

# 06.

**Scorrevole  
in nicchia**  
Rosso Casale + vetro trasparente

*Sliding door  
in niche*  
in Rosso Casale + trasparente glass

*Porte coulissante  
en niche*  
en Rosso Casale + verre transparente



---

Piatto doccia:  
**Parallel Rosso Casale**  
L 120 x P 80 cm

*Shower tray:*  
**Parallel Rosso Casale**  
W 120 x D 80 cm

*Receveur:*  
**Parallel Rosso Casale**  
L 120 x P 80 cm

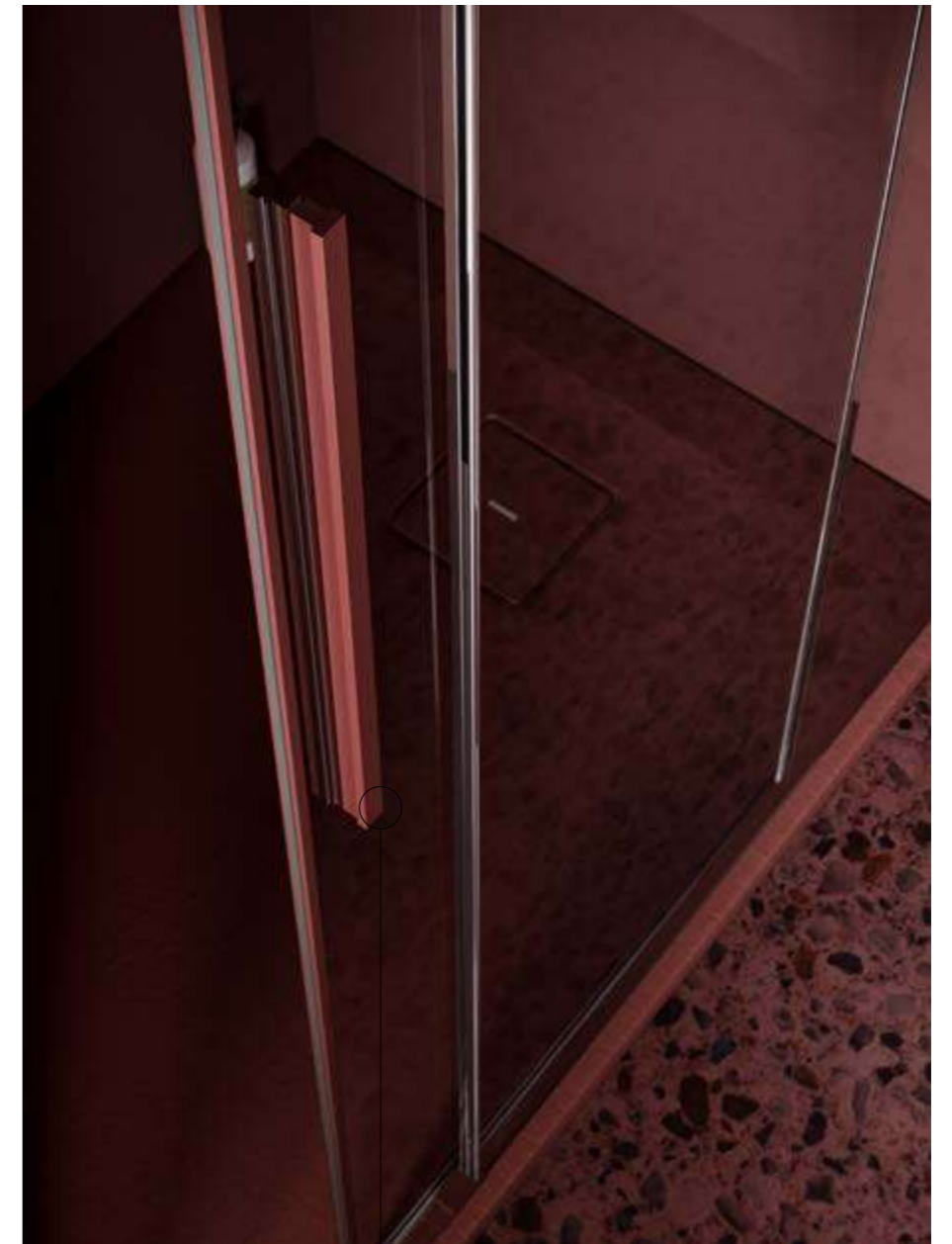

**Maniglia Ti:**  
un'alternativa  
lineare alla  
maniglia di serie

**Ti handle:**  
a linear alternative  
to the standard handle

**Poignée Ti:**  
une alternative linéaire  
à la poignée de série

**La traversa vista dall'interno del box:**  
pensata per garantire linee eleganti e facilità di pulizia

**The crossbar seen from the inside:**  
conceived to present an elegant solution and for easiness of cleaning

**La barre transversale vue de l'intérieur de la cabine de douche:**  
elle est conçue pour présenter des lignes élégantes et pour permettre un nettoyage facile

**Soft-close di serie:**  
per rendere più confortevoli l'apertura e la chiusura del box

**Soft-close system as standard:**  
to open and close the box easily

**Mécanisme Soft-close de série:**  
il rend l'ouverture et la fermeture plus confortables

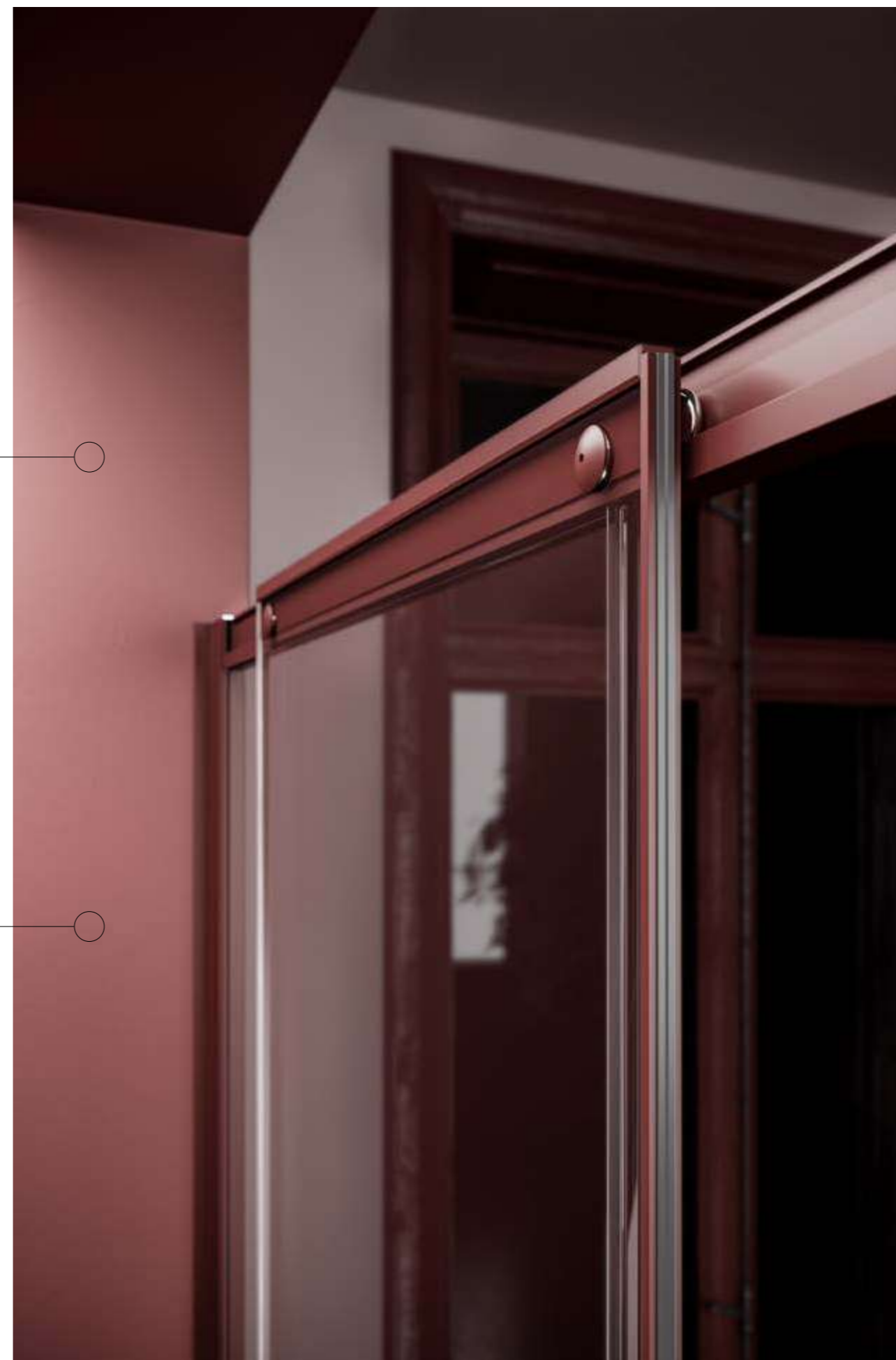

# 07.

**Scorrevole  
in nicchia**  
nero + vetro trasparente

*Sliding door  
in niche*  
in nero + trasparente glass

*Porte coulissante  
en niche*  
nero + transparente glass



---

Piatto doccia:  
**Parallel Laguna**  
L 140 x P 80 cm

Shower tray:  
**Parallel Laguna**  
W 140 x D 80 cm

Receveur:  
**Parallel Laguna**  
L 140 x P 80 cm



**IBRA**  
SHOWERS

*BOX DOCCIA  
SHOWER ENCLOSURES  
PAROIS DE DOUCHE*

**LODE**  
> 6 mm

LODE

## Caratteristiche / features / caractéristiques

> H 200 cm	> H 200 cm	> H 200 cm
> Chiusura a calamita inserita su profilo in alluminio	> Magnetic closing system inserted in the aluminium profile	> Fermeture magnetique inserée dans le profil en aluminium
> Profili gocciolatoi in PVC trasparente antigoccia	> Drip sealing strips in transparent PVC anti-mould	> Profils en PVC contre l'éclaboussement
> Profilo inferiore di contenimento acqua	> Water containment channel	> Profils inférieur pour le confinement de l'eau
> Braccetti di sostegno in alluminio accorciabili in opera	> Aluminium stabilising bar to be cutted during installation	> Soutiens en aluminium à couper en cours de réalisation
> Profili verticali dotati di tappi di chiusura trasparenti	> Transparent upper covers for the adjustment profile	> Profils verticaux avec bouchons de fermeture transparents
> Possibilità di fuori misura	> Out of standard on request	> Hors standard sur demande
> Reversibile	> Reversible	> Reversible

## Vetri / glasses / verre



<b>00</b> Trasparente	<b>GE</b> Grigio Europa	<b>SA</b> Satinato	<b>BZ</b> Bronzo	<b>X1</b> Nuvola	<b>TL</b> Timeless	<b>EC</b> Extrachiaro
						<b>X2-X3-X4-X5</b> Serigrafie (v. pag. 371) Serigraphies (s. page. 371) Sérigraphies (s. pag. 371)

## Profili / profiles / profils

### SPECIAL:



<b>B</b> Brill	<b>N</b> Nero	<b>9</b> Laccato Lacquered Laqué
-------------------	------------------	---



**FIRMA**  
maniglia di serie  
as standard  
de série

- > Fissata sul vetro
- > Fixed to the glass
- > Fixée au verre



**TI**  
alternativa (specificare nell'ordine)  
optional (to specify in the order)  
alternative (indiquer dans la commande)

- > Fissata sul vetro
- > Fixed to the glass
- > Fixée au verre



**WING**  
alternativa (specificare nell'ordine)  
optional (to specify in the order)  
alternative (indiquer dans la commande)

- > Fissata sul vetro
- > Fixed to the glass
- > Fixée au verre

## Configurazioni / configurations / configurations

<b>NICCHIA</b> > Pivot	<b>NICCHIA</b> > Pivot + fisso in linea	<b>NICCHIA</b> > Pivot 2 porte	<b>ANGOLO</b> > Pivot a muro con fisso in linea e laterale fisso	<b>ANGOLO</b> > Pivot con fisso in linea e laterale fisso	<b>ANGOLO</b> > Pivot con laterale fisso
Pivot door	Pivot door with in-line fixed panel	2 pivot doors	Pivot door with in-line fixed panel + fixed panel	Pivot door with in-line fixed panel + fixed panel	Pivot door + fixed panel
Porte pivotante	Porte pivotante + paroi fixe alignées	2 portes pivotantes	Porte pivotante en coin + paroi fixe et côté fixe	Porte pivotante en coin + paroi fixe et côté fixe	Porte pivotante avec côté fixe

## LODE - NICCHIA - PORTA PIVOT NICHE - PIVOT DOOR NICHE - PORTE PIVOTANTE

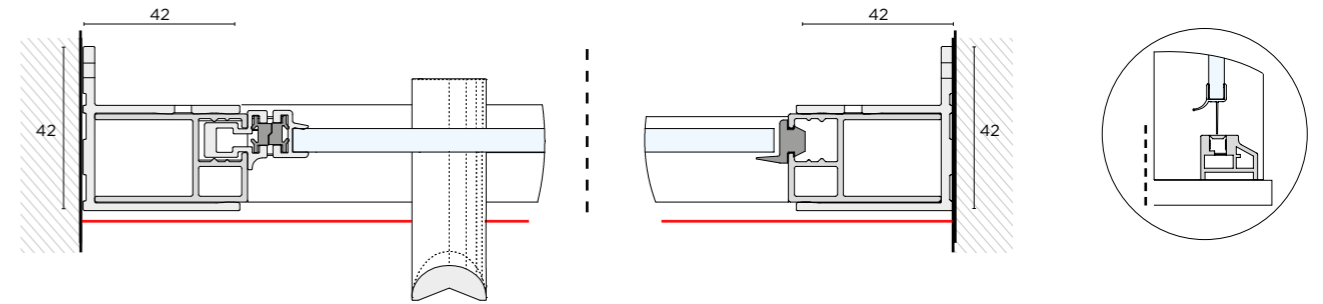

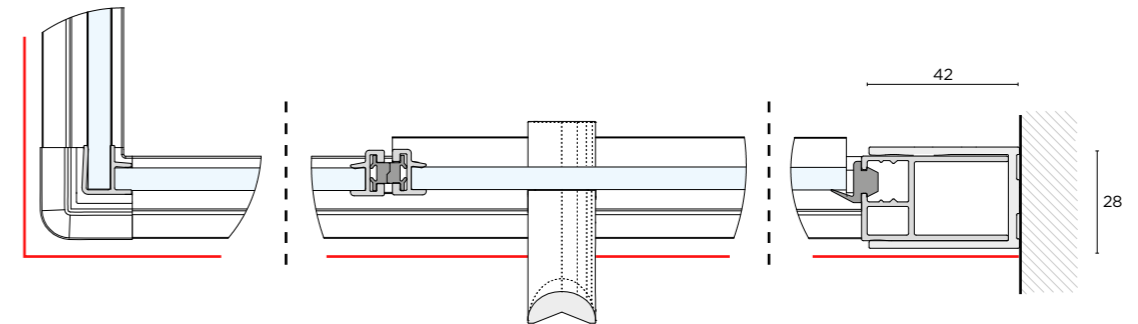

## LODE - ANGOLO - PORTA PIVOT CON FISSO IN LINEA CORNER - PIVOT DOOR COIN - PORTE PIVOTANTE

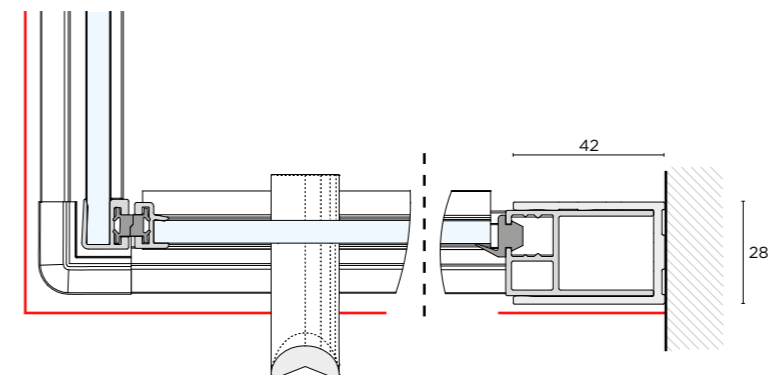

## LODE - ANGOLO - PORTA PIVOT CORNER - PIVOT DOOR COIN - PORTE PIVOTANTE

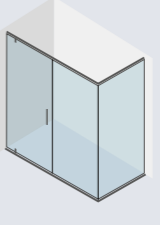
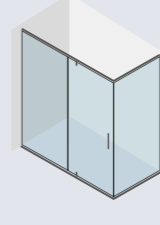
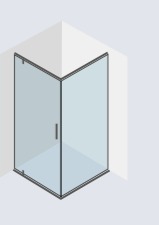

## LODE PIVOT CON TRAVERSA

					
<b>NICCHIA</b> > Pivot	<b>NICCHIA</b> > Pivot + fisso in linea	<b>NICCHIA</b> > Pivot 2 porte	<b>ANGOLO</b> > Pivot a muro con fisso in linea e laterale fisso	<b>ANGOLO</b> > Pivot con fisso in linea e laterale fisso	<b>ANGOLO</b> > Pivot con laterale fisso
Pivot door	Pivot door with in-line fixed panel	2 pivot doors	Pivot door with in-line fixed panel + fixed panel	Pivot door with in-line fixed panel + fixed panel	Pivot door + fixed panel
Porte pivotante	Porte pivotante + paroi fixe alignées	2 portes pivotantes	Porte pivotante en coin + paroi fixe et côté fixe	Porte pivotante en coin + paroi fixe et côté fixe	Porte pivotante avec côté fixe

## LODE: PIVOT CON TRAVERSA PIVOT WITH CROSSBAR PIVOTANTE AVEC BARRE

### Dettagli / details / détails



**Maniglia di serie:**  
A ponte, con un comodo pomolo per l'apertura dall'interno.

**Standard handle:**  
With a bridge shape and a knob to open from the inside.

**Poignée de série:**  
À pont, avec un bouton pratique pour ouvrir la porte de l'intérieur.



**Angolo stondato:**  
Per rifinire il punto d'incontro dei profili perimetrali.

**Rounded corner:**  
To finish off the point where the perimeter profiles meet.

**Coin arrondi:**  
Pour delimitar le point de reincontre des profils de périmètre.



**Cerniera per pivot con traversa:**  
Un sistema di apertura per piccoli e grandi spazi.

**Hinge for pivot door with crosspiece:**  
An opening system for large and small spaces.

**Charnière pour porte pivotante avec barre transversale:**  
C'est un système d'ouverture utilisable pour des espaces grands ou petits.

### LEGENDA

KEY / LÉGENDE

**F** fisso / fixed panel / côté fixe  
**L** lato / fixed lateral panel / côté fixe latéral  
**A** apertura / opening / entrée  
**P** porta / door / porte





# 01.

**Pivot con  
fisso in linea**  
brill + vetro trasparente

*Pivot door with  
in-line fixed panel*  
in brill + trasparente glass

**Porte pivotante  
+ paroi fixe alignée**  
brill + verre transparente

---

Piatto doccia:  
**Aureo Laminam Pietra Piasentina**  
L 120 x P 80 cm

*Shower tray:*  
**Aureo Laminam Pietra Piasentina**  
W 120 x D 80 cm

*Receveur:*  
**Aureo Laminam Pietra Piasentina**  
L 120 x P 80 cm



**Apertura pivot**  
con cerniere  
regolabili - Fissaggio  
interno a filo vetro

**Pivot opening**  
with adjustable  
hinges - Internal fixing  
flush to the glass

**Ouverture pivot**  
avec charnières  
réglables - Fixation  
interne au ras du verre





## 02.

**1 porta pivot  
in nicchia**  
brill + vetro trasparente

*Pivot door  
in niche*  
in brill + trasparente glass

*Porte pivotante  
en niche*  
brill + verre transparente

---

Piatto doccia:  
**Linear Tortora**  
L 80 x P 80 cm

Shower tray:  
**Linear Tortora**  
W 80 x D 80 cm

Receveur:  
**Linear Tortora**  
L 80 x P 80 cm





## 03.

**Porta pivot  
con fisso in linea + fisso laterale**  
nero + vetro trasparente

*Pivot door with in-line fixed panel  
+ fixed lateral panel  
in nero + trasparente glass*

*Porte pivotante  
avec paroi fixe alignée  
+ côté fixe latéral  
en nero + verre transparente*

---

Piatto doccia:  
**Linear Bianco**  
L 120 x P 80 cm

Shower tray:  
**Linear Bianco**  
W 120 x D 80 cm

Receveur:  
**Linear Bianco**  
L 120 x P 80 cm



**Cerniera  
pivot:**  
eleganza e  
attenzione al  
dettaglio

**Pivot hinge:**  
elegance and attention  
to the detail

**Charnière pivot:**  
elegance et attention  
au détail



## 04.

**Porta pivot ad angolo  
con fisso in linea + fisso laterale**  
nero + vetro Grigio Europa

*Pivot door with in-line fixed panel  
+ fixed lateral panel*  
in nero + Grigio Europa glass

*Porte pivotante  
avec paroi fixe alignée  
+ côté fixe latéral*  
nero + verre Grigio Europa

---

Piatto doccia:  
**Linear Bianco**  
L 120 x P 80 cm

Shower tray:  
**Linear Bianco**  
W 120 x D 80 cm

Receveur:  
**Linear Bianco**  
L 120 x P 80 cm





**Guarnizione magnetica nera**

**Black magnetic gasket**

**Joint magnétique noir**

**Cerniera pivot:**  
eleganza e attenzione al dettaglio

**Pivot hinge:**  
elegance and attention to the detail

**Charnière pivot:**  
elegance et attention au détail





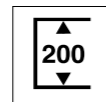

**Altezza 200 cm**  
Height 200 cm  
Hauteur 200 cm



**Vetro sp. 6 mm**  
Glass th. 6 mm  
Verre ép. 6 mm



**Fuori misura:**  
**altezza max 210 cm / larghezza max 100 cm**  
Out of standard:  
height max. 210 cm / width max. 100 cm  
Sur demande:  
hauteur max. 210 cm / largeur max. 100 cm



**Cerniere regolabili**  
Adjustable hinges  
Réglage sur les charnières



**Reversible**  
Reversible  
Réversible

**Configurazioni:**  
Configurations:  
Configurations:

**VERSIONE SX**  
Left  
Gauche

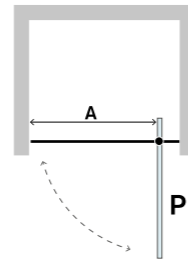
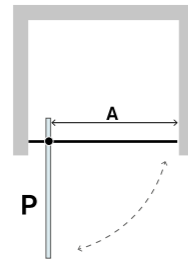

**VERSIONE DX**  
Right  
Droite

**Fuori Misura:**  
Out of standard:  
Sur mesure:



**(richiedere fattibilità)**  
(ask for feasibility)  
(vérifier la faisabilité avec le service technique)

**Trattamento anticalcare:**  
Glass treatment:  
Traitement verre:



**Lato**  
Side  
Verre

**Vetro Extralight / Timeless:**  
Extralight/Timeless glass:  
Verre Extralight/Timeless:



**Vetro con serigrafie:**  
Serigraphies (see page 371):  
Sérigraphies (voir page 371):



**maggiorazione dal TRASPARENTE**  
increase on the TRASPARENTE price  
à partir du prix du TRASPARENTE

**Vetro Nuvola:**  
Nuvola glass (see page 371):  
Verre Nuvola (voir page 371):



**Profili speciali:**  
Special profiles:  
Profils special:

- > LACCATO
- > LACQUERED
- > LAQUE



**Porta**  
Door  
Porte



**P - PORTA PIVOT / PIVOT DOOR / PORTE PIVOTANTE**

ART. ITEM ART.	ESTENSIBILITÀ EXTENSIBILITY EXTENSIBILITÉ	PIATTO TRAY RECEVEUR	APERTURA OPENING ENTRÉE	PROFILO PROFILE PROFIL	VETRO/GLASS/VERRE TRASPARENTE	VETRO/GLASS/VERRE GRIGIO EUROPA SATIN - BRONZO
D6PN600	65 - 69	70	43	BRILL		
				NERO		
D6PN605	70 - 74	75	48	BRILL		
				NERO		
D6PN610	75 - 79	80	53	BRILL		
				NERO		
D6PN615	80 - 84	85	58	BRILL		
				NERO		
D6PN620	85 - 89	90	63	BRILL		
				NERO		

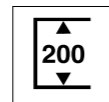

**Altezza 200 cm**  
Height 200 cm  
Hauteur 200 cm

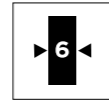

**Vetro sp. 6 mm**  
Glass th. 6 mm  
Verre ép. 6 mm



**Fuori misura:**  
**altezza max 210 cm / larghezza max 180 cm**  
Out of standard:  
height max. 210 cm / width max. 180 cm  
Sur demande:  
hauteur max. 210 cm / largeur max. 180 cm



**Cerniere regolabili**  
Adjustable hinges  
Réglage sur les charnières



**Reversible**  
Reversible  
Réversible

**Configurazioni:**  
Configurations:  
Configurations:

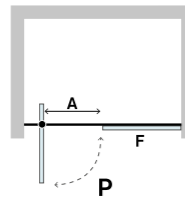

**VERSIONE SX**  
Left  
Gauche

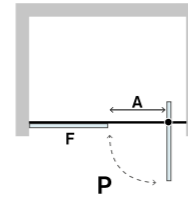

**VERSIONE DX**  
Right  
Droite

**Fuori Misura:**  
Out of standard:  
Sur mesure:



**(richiedere fattibilità)**  
(ask for feasibility)  
(vérifier la faisabilité avec le service technique)

**Trattamento anticalcare:**  
Glass treatment:  
Traitement verre:



**Lato**  
Side  
Verre

**Vetro Extralight / Timeless:**  
Extralight/Timeless glass:  
Verre Extralight/Timeless:



**Vetro con serigrafie:**  
Serigraphies (see page 371):  
Sérigraphies (voir page 371):



**maggiorazione dal TRASPARENTE**  
increase on the TRASPARENTE price  
à partir du prix du TRASPARENTE

**Vetro Nuvola:**  
Nuvola glass (see page 371):  
Verre Nuvola (voir page 371):



**Profili speciali:**  
Special profiles:  
Profils special:

- > LACCATO
- > LACQUERED
- > LAQUE

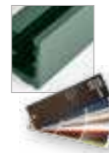

**Porta**  
Door  
Porte



**P - PORTA PIVOT / PIVOT DOOR / PORTE PIVOTANTE**

ART. ITEM ART.	ESTENSIBILITÀ EXTENSIBILITY EXTENSIBILITÉ	PIATTO TRAY RECEVEUR	APERTURA OPENING ENTRÉE	FISSO FIXED FIXE	PROFILO PROFILE PROFIL	VETRO/GLASS/VERRE TRASPARENTE	VETRO/GLASS/VERRE GRIGIO EUROPA SATIN - BRONZO
D6PN200	85 - 89	90	56	14	BRILL		
					NERO		
D6PN205	90 - 94	95	56	19	BRILL		
					NERO		
D6PN210	95 - 99	100	56	24	BRILL		
					NERO		
D6PN215	100 - 104	105	56	29	BRILL		
					NERO		
D6PN220	105 - 109	110	56	34	BRILL		
					NERO		
D6PN225	110 - 114	115	56	39	BRILL		
					NERO		
D6PN230	115 - 119	120	56	44	BRILL		
					NERO		
D6PN235	120 - 124	125	56	49	BRILL		
					NERO		
D6PN240	125 - 129	130	56	54	BRILL		
					NERO		
D6PN245	130 - 134	135	56	59	BRILL		
					NERO		
D6PN250	135 - 139	140	66	54	BRILL		
					NERO		
D6PN255	140 - 144	145	66	59	BRILL		
					NERO		
D6PN260	145 - 149	150	66	64	BRILL		
					NERO		
D6PN265	150 - 154	155	66	69	BRILL		
					NERO		
D6PN270	155 - 159	160	66	74	BRILL		
					NERO		
D6PN275	160 - 164	165	66	79	BRILL		
					NERO		
D6PN280	165 - 169	170	66	84	BRILL		
					NERO		
D6PN285	170 - 174	175	66	89	BRILL		
					NERO		
D6PN290	175 - 179	180	66	94	BRILL		
					NERO		

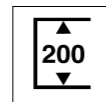

**Altezza 200 cm**  
Height 200 cm  
Hauteur 200 cm



**Vetro sp. 6 mm**  
Glass th. 6 mm  
Verre ép. 6 mm



**Fuori misura:**  
**altezza max 210 cm / larghezza max 160 cm**  
Out of standard:  
height max. 210 cm / width max. 160 cm  
Sur demande:  
hauteur max. 210 cm / largeur max. 160 cm



**Cerniere regolabili**  
Adjustable hinges  
Réglage sur les charnières



**Reversibile**  
Reversible  
Réversible

**Configurazioni:**  
Configurations:  
Configurations:

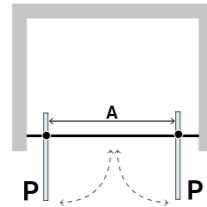

**Fuori Misura:**  
Out of standard:  
Sur mesure:



**(richiedere fattibilità)**  
(ask for feasibility)  
(vérifier la faisabilité avec le service technique)

**Trattamento anticalcare:**  
Glass treatment:  
Traitement verre:



**Lato**  
Side  
Verre

**Vetro Extralight / Timeless:**  
Extralight/Timeless glass:  
Verre Extralight/Timeless:



**Vetro con serigrafie:**  
Serigraphies (see page 371):  
Sérigraphies (voir page 371):



**maggiorazione dal TRASPARENTE**  
increase on the TRASPARENTE price  
à partir du prix du TRASPARENTE

**Vetro Nuvola:**  
Nuvola glass (see page 371):  
Verre Nuvola (voir page 371):



**Profili speciali:**  
Special profiles:  
Profils special:

> LACCATO  
> LACQUERED  
> LAQUE

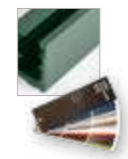

**Porta**  
Door  
Porte

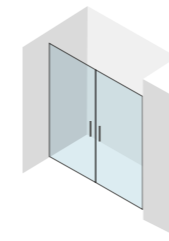

## P - PORTA PIVOT / PIVOT DOOR / PORTE PIVOTANTE

ART. ITEM ART.	ESTENSIBILITÀ EXTENSIBILITY EXTENSIBILITÉ	PIATTO TRAY RECEVEUR	APERTURA OPENING ENTRÉE		PROFILO PROFILE PROFIL	VETRO/GLASS/VERRE TRASPARENTE	VETRO/GLASS/VERRE GRIGIO EUROPA SATIN - BRONZO
D6PN700	85 - 89	90	55		BRILL		
					NERO		
D6PN705	90 - 94	95	60		BRILL		
					NERO		
D6PN710	95 - 99	100	65		BRILL		
					NERO		
D6PN715	100 - 104	105	70		BRILL		
					NERO		
D6PN720	105 - 109	110	75		BRILL		
					NERO		
D6PN725	110 - 114	115	80		BRILL		
					NERO		
D6PN730	115 - 119	120	85		BRILL		
					NERO		
D6PN735	120 - 124	125	90		BRILL		
					NERO		
D6PN740	125 - 129	130	95		BRILL		
					NERO		
D6PN745	130 - 134	135	100		BRILL		
					NERO		
D6PN750	135 - 139	140	105		BRILL		
					NERO		

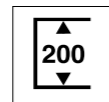

**Altezza 200 cm**  
Height 200 cm  
Hauteur 200 cm

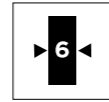

**Vetro sp. 6 mm**  
Glass th. 6 mm  
Verre ép. 6 mm



**Fuori misura:**  
**altezza max 210 cm / larghezza max 180 cm / profondità max 120 cm**  
Out of standard:  
height max. 210 cm / width max. 180 cm /  
depth max. 120 cm  
Sur demande:  
hauteur max. 210 cm / largeur max. 180 cm /  
profondeur max. 120 cm



**Cerniere regolabili**  
Adjustable hinges  
Réglage sur les charnières



**Reversibile**  
Reversible  
Réversible

**Configurazioni:**  
Configurations:  
Configurations:

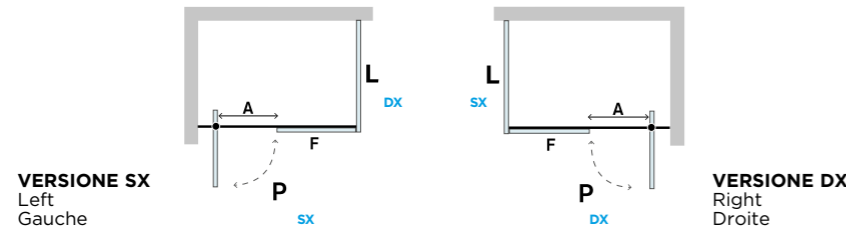

**Fuori Misura:**  
Out of standard:  
Sur mesure:



**(richiedere fattibilità)**  
(ask for feasibility)  
(vérifier la faisabilité avec le service technique)

**Trattamento anticalcare:**  
Glass treatment:  
Traitement verre:



**Lato**  
Side  
Verre

**Vetro Extralight / Timeless:**  
Extralight/Timeless glass:  
Verre Extralight/Timeless:



**Vetro con serigrafie:**  
Serigraphies (see page 371):  
Sérigraphies (voir page 371):



**maggiorazione dal TRASPARENTE**  
increase on the TRASPARENTE price  
à partir du prix du TRASPARENTE

**Vetro Nuvola:**  
Nuvola glass (see page 371):  
Verre Nuvola (voir page 371):



**Profili speciali:**  
Special profiles:  
Profils special:

- > LACCATO
- > LACQUERED
- > LAQUE



**Porta**  
Door  
Porte

**Fisso**  
Fixed panel  
Côté fixe

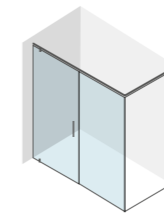

**P - PORTA PIVOT / PIVOT DOOR / PORTE PIVOTANTE**

ART. ITEM ART.	ESTENSIBILITÀ EXTENSIBILITY EXTENSIBILITÉ	PIATTO TRAY RECEVEUR	APERTURA OPENING ENTRÉE	FISSO FIXED FIXE	PROFILO PROFILE PROFIL	VETRO/GLASS/VERRE TRASPARENTE	VETRO/GLASS/VERRE GRIGIO EUROPA SATIN - BRONZO
D6PA100	87,5 - 89,5	90	56	19	BRILL NERO		
D6PA105	92,5 - 94,5	95	56	24	BRILL NERO		
D6PA110	97,5 - 99,5	100	56	29	BRILL NERO		
D6PA115	102,5 - 104,5	105	56	34	BRILL NERO		
D6PA120	107,5 - 109,5	110	56	39	BRILL NERO		
D6PA125	112,5 - 114,5	115	56	44	BRILL NERO		
D6PA130	117,5 - 119,5	120	56	49	BRILL NERO		
D6PA135	122,5 - 124,5	125	56	54	BRILL NERO		
D6PA140	127,5 - 129,5	130	56	59	BRILL NERO		
D6PA145	132,5 - 134,5	135	56	64	BRILL NERO		
D6PA150	137,5 - 139,5	140	66	59	BRILL NERO		
D6PA155	142,5 - 144,5	145	66	64	BRILL NERO		
D6PA160	147,5 - 149,5	150	66	69	BRILL NERO		
D6PA165	152,5 - 154,5	155	66	74	BRILL NERO		
D6PA170	157,5 - 159,5	160	66	79	BRILL NERO		
D6PA175	162,5 - 164,5	165	66	84	BRILL NERO		
D6PA180	167,5 - 169,5	170	66	89	BRILL NERO		
D6PA185	172,5 - 174,5	175	66	94	BRILL NERO		
D6PA190	177,5 - 179,5	180	66	99	BRILL NERO		

**L - FISSO / FIXED LATERAL PANEL / CÔTÉ FIXE LATÉRAL**

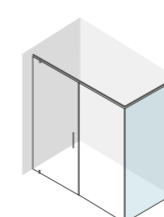

ART. ITEM ART.	ESTENSIBILITÀ EXTENSIBILITY EXTENSIBILITÉ	PIATTO TRAY RECEVEUR			PROFILO PROFILE PROFIL	VETRO/GLASS/VERRE TRASPARENTE	VETRO/GLASS/VERRE GRIGIO EUROPA SATIN - BRONZO
D6PA195	67,5 - 69,5	70			BRILL NERO		
D6PA200	72,5 - 74,5	75			BRILL NERO		
D6PA205	77,5 - 79,5	80			BRILL NERO		
D6PA210	82,5 - 84,5	85			BRILL NERO		
D6PA215	87,5 - 89,5	90			BRILL NERO		
D6PA220	92,5 - 94,5	95			BRILL NERO		
D6PA225	97,5 - 99,5	100			BRILL NERO		

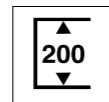

**Altezza 200 cm**  
Height 200 cm  
Hauteur 200 cm

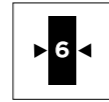

**Vetro sp. 6 mm**  
Glass th. 6 mm  
Verre ép. 6 mm



**Fuori misura:**  
**altezza max 210 cm / larghezza max 180 cm /**  
**profondità max 120 cm**  
Out of standard:  
height max. 210 cm / width max. 180 cm /  
depth max. 120 cm  
Sur demande:  
hauteur max. 210 cm / largeur max. 180 cm /  
profondeur max. 120 cm



**Cerniere regolabili**  
Adjustable hinges  
Réglage sur les charnières



**Reversibile**  
Reversible  
Réversible

**Configurazioni:**  
Configurations:  
Configurations:

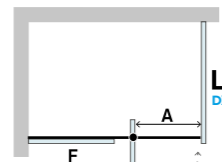

**VERSIONE SX**  
Left  
Gauche

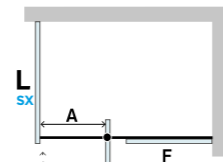

**VERSIONE DX**  
Right  
Droite

**Fuori Misura:**  
Out of standard:  
Sur mesure:



**(richiedere fattibilità)**  
(ask for feasibility)  
(vérifier la faisabilité avec le service technique)

**Trattamento anticalcare:**  
Glass treatment:  
Traitement verre:



**Lato**  
Side  
Verre

**Vetro Extralight / Timeless:**  
Extralight/Timeless glass:  
Verre Extralight/Timeless:



**Vetro con serigrafie:**  
Serigraphies (see page 371):  
Sérigraphies (voir page 371):



**maggiorazione dal TRASPARENTE**  
increase on the TRASPARENTE price  
à partir du prix du TRASPARENTE

**Vetro Nuvola:**  
Nuvola glass (see page 371):  
Verre Nuvola (voir page 371):



**Profili speciali:**  
Special profiles:  
Profils special:

- > LACCATO
- > LACQUERED
- > LAQUE



**Porta**  
Door  
Porte

**Fisso**  
Fixed panel  
Côté fixe

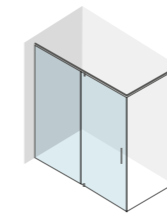

**P - PORTA PIVOT / PIVOT DOOR / PORTE PIVOTANTE**

ART. ITEM ART.	ESTENSIBILITÀ EXTENSIBILITÉ	PIATTO TRAY RECEVEUR	APERTURA OPENING ENTRÉE	FISSO FIXED FIXE	PROFILO PROFILE PROFIL	VETRO/GLASS/VERRE TRASPARENTE	VETRO/GLASS/VERRE GRIGIO EUROPA SATIN - BRONZO
D6PA300	87,5 - 89,5	90	57	18	BRILL NERO		
D6PA305	92,5 - 94,5	95	57	23	BRILL NERO		
D6PA310	97,5 - 99,5	100	57	28	BRILL NERO		
D6PA315	102,5 - 104,5	105	57	33	BRILL NERO		
D6PA320	107,5 - 109,5	110	57	38	BRILL NERO		
D6PA325	112,5 - 114,5	115	57	43	BRILL NERO		
D6PA330	117,5 - 119,5	120	57	48	BRILL NERO		
D6PA335	122,5 - 124,5	125	57	53	BRILL NERO		
D6PA340	127,5 - 129,5	130	57	58	BRILL NERO		
D6PA345	132,5 - 134,5	135	57	63	BRILL NERO		
D6PA350	137,5 - 139,5	140	57	68	BRILL NERO		
D6PA355	142,5 - 144,5	145	57	73	BRILL NERO		
D6PA360	147,5 - 149,5	150	57	78	BRILL NERO		
D6PA365	152,5 - 154,5	155	57	83	BRILL NERO		
D6PA370	157,5 - 159,5	160	57	88	BRILL NERO		
D6PA375	162,5 - 164,5	165	57	93	BRILL NERO		
D6PA380	167,5 - 169,5	170	57	98	BRILL NERO		
D6PA385	172,5 - 174,5	175	57	103	BRILL NERO		
D6PA390	177,5 - 179,5	180	57	108	BRILL NERO		

**L - FISSO / FIXED LATERAL PANEL / CÔTÉ FIXE LATÉRAL**

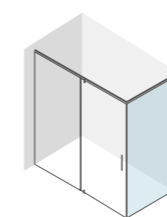

ART. ITEM ART.	ESTENSIBILITÀ EXTENSIBILITÉ	PIATTO TRAY RECEVEUR			PROFILO PROFILE PROFIL	VETRO/GLASS/VERRE TRASPARENTE	VETRO/GLASS/VERRE GRIGIO EUROPA SATIN - BRONZO
D6PA395	67,5 - 69,5	70			BRILL NERO		
D6PA400	72,5 - 74,5	75			BRILL NERO		
D6PA405	77,5 - 79,5	80			BRILL NERO		
D6PA410	82,5 - 84,5	85			BRILL NERO		
D6PA415	87,5 - 89,5	90			BRILL NERO		
D6PA420	92,5 - 94,5	95			BRILL NERO		
D6PA425	97,5 - 99,5	100			BRILL NERO		

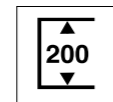

**Altezza 200 cm**  
Height 200 cm  
Hauteur 200 cm



**Vetro sp. 6 mm**  
Glass th. 6 mm  
Verre ép. 6 mm



**Fuori misura:**  
**altezza max 210 cm / larghezza max 100 cm / profondità max 120 cm**  
Out of standard:  
height max. 210 cm / width max. 100 cm / depth max. 120 cm  
Sur demande:  
hauteur max. 210 cm / largeur max. 100 cm / profondeur max. 120 cm



**Cerniere regolabili**  
Adjustable hinges  
Réglage sur les charnières

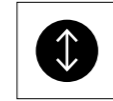

**Reversibile**  
Reversible  
Réversible

**Configurazioni:**  
Configurations:  
Configurations:

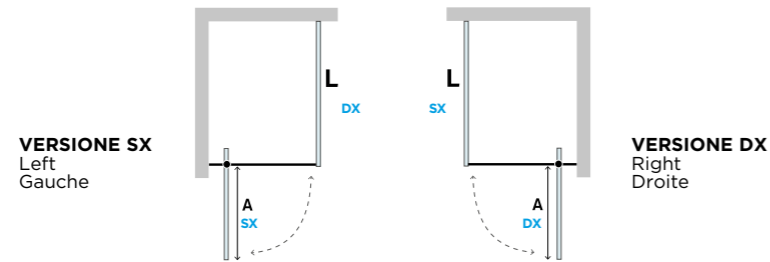

**Fuori Misura:**  
Out of standard:  
Sur mesure:



**(richiedere fattibilità)**  
(ask for feasibility)  
(vérifier la faisabilité avec le service technique)

**Trattamento anticalcare:**  
Glass treatment:  
Traitement verre:



**Lato**  
Side  
Verre

**Vetro Extralight / Timeless:**  
Extralight/Timeless glass:  
Verre Extralight/Timeless:



**Vetro con serigrafie:**  
Serigraphies (see page 371):  
Sérigraphies (voir page 371):



**maggiorazione dal TRASPARENTE**  
increase on the TRASPARENTE price  
à partir du prix du TRASPARENTE

**Vetro Nuvola:**  
Nuvola glass (see page 371):  
Verre Nuvola (voir page 371):



**Profili speciali:**  
Special profiles:  
Profils special:

- > LACCATO
- > LACQUERED
- > LAQUE

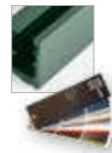

**Porta**  
Door  
Porte

**Fisso**  
Fixed panel  
Côté fixe

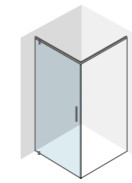



**P - PORTA PIVOT / PIVOT DOOR / PORTE PIVOTANTE**

ART. ITEM ART.	ESTENSIBILITÀ EXTENSIBILITY EXTENSIBILITÉ	PIATTO TRAY RECEVEUR	APERTURA OPENING ENTRÉE	PROFILO PROFILE PROFIL	VETRO/GLASS/VERRE TRASPARENTE	VETRO/GLASS/VERRE GRIGIO EUROPA SATIN - BRONZO
D6PA500	67,5 - 69,5	70	50	BRILL		
				NERO		
D6PA505	72,5 - 74,5	75	55	BRILL		
				NERO		
D6PA510	77,5 - 79,5	80	60	BRILL		
				NERO		
D6PA515	82,5 - 84,5	85	65	BRILL		
				NERO		
D6PA520	87,5 - 89,5	90	70	BRILL		
				NERO		

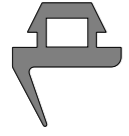

**L - FISSO / FIXED LATERAL PANEL / CÔTÉ FIXE LATÉRAL**

ART. ITEM ART.	ESTENSIBILITÀ EXTENSIBILITY EXTENSIBILITÉ	PIATTO TRAY RECEVEUR		PROFILO PROFILE PROFIL	VETRO/GLASS/VERRE TRASPARENTE	VETRO/GLASS/VERRE GRIGIO EUROPA SATIN - BRONZO
D6PA395	67,5 - 69,5	70		BRILL		
				NERO		
D6PA400	72,5 - 74,5	75		BRILL		
				NERO		
D6PA405	77,5 - 79,5	80		BRILL		
				NERO		
D6PA410	82,5 - 84,5	85		BRILL		
				NERO		
D6PA415	87,5 - 89,5	90		BRILL		
				NERO		
D6PA420	92,5 - 94,5	95		BRILL		
				NERO		
D6PA425	97,5 - 99,5	100		BRILL		
				NERO		
D6PA430	102,5 - 104,5	105		BRILL		
				NERO		
D6PA435	107,5 - 109,5	110		BRILL		
				NERO		
D6PA440	112,5 - 114,5	115		BRILL		
				NERO		
D6PA445	117,5 - 119,5	120		BRILL		
				NERO		

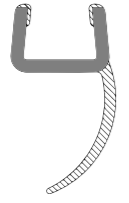
DISEGNO DRAWING DESSIN	DESCRIZIONE DESCRIPTION DESCRIPTION	FINITURA FINISH FINITION	ART. ITEM ART.
	GUARNIZIONE VERTICALE <b>MONTANTE</b>  VERTICAL GASKET <b>WALL PROFILE</b>  JOINT VERTICAL <b>PROFIL À MUR</b>		DGMA0080
	GUARNIZIONE INFERIORE <b>PORTA</b>  PIVOT <b>DOOR</b> BORROM GASKET  JOINT INFÉRIEUR POUR <b>PORTE</b> PIVOTANTE		DGMA0160
	GUARNIZIONE VERTICALE <b>PORTA</b>  PIVOT <b>DOOR</b> VERTICAL GASKET  JOINT VERTICAL POUR <b>PORTE</b> PIVOTANTE		DGMA0090

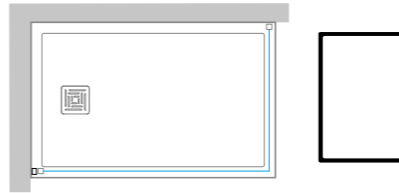
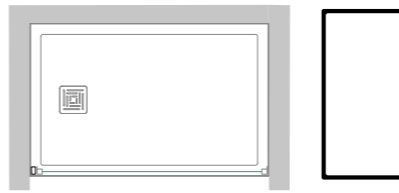
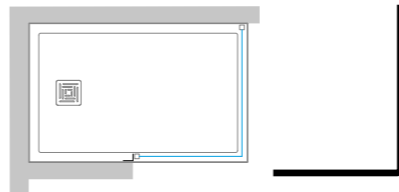
DISEGNO DRAWING DESSIN	DESCRIZIONE DESCRIPTION DESCRIPTION	FINITURA FINISH FINITION	ART. ITEM ART.
	PROFILO ALLUNGAMENTO ANGOLO <b>30 x 20 x 2000</b>	BRILL	DPAU003B
	SHIM PROFILE IN CORNER <b>30 x 20 x 2000</b>	NERO	DPAU003N
	PROFILLE DE COMPENSATION EN COIN <b>30 x 20 x 2000</b>	SPECIAL	DPAU003*
	PROFILO ALLUNGAMENTO NICCHIA <b>40 x 20 x 2000</b>	BRILL	DPAU002B
	SHIM PROFILE IN NICHE <b>40 x 20 x 2000</b>	NERO	DPAU002N
	PROFILLE DE COMPENSATION EN NICHE <b>40 x 20 x 2000</b>	SPECIAL	DPAU002*
	PROFILO FISSAGGIO LATERALE <b>40 x 30 x 2000</b>	BRILL	DPAU001B
	LATERAL FIXING PROFILE <b>40 x 30 x 2000</b>	NERO	DPAU001N
	PROFILLE POUR FIXATION LATÉRALE <b>40 x 30 x 2000</b>	SPECIAL	DPAU001*